



FEATURES

- ◆ Efficiency up to 96%
- ◆ No need for heat sinks
- ◆ 0.5AMP SMD package
- ◆ Wide input voltage range(4.5V~28V)
- ◆ Adjustable output voltage
- ◆ Remote ON/OFF control
- ◆ Short circuit protection,Thermal shutdown
- ◆ Very low shutdown current
- ◆ Super low ripple and noise

MODEL SELECTION

WRN78^①05^②T^③-500^④

- ① Product Series ② Output Voltage
 ③ SMD Package Style ④ Output Current

APPLICATIONS

The WRN78xxT-500 series with high efficiency switching regulators are ideally supply for space constrained mobile applications . They are no need for any heat sinks , even if operate at +85℃ . The additional features include remote ON/OFF control and adjustable output voltage.Super low ripple and noise of typically only 10mV and a shutdown input current of typically only 15uA .

PRODUCT PROGRAM

Part Number	Input Voltage(VDC)		Output Voltage (VDC)		Current (mA)	Efficiency(% Typ)	
	Nominal	Range	Normal	Adjust Range		Vin (min.)	Vin (max.)
WRN7803T-500	12	4.5-28	3.3	1.8-5.5	500	90	75
WRN7805T-500	12	6.0-28	5.0	2.5-8.0	500	94	81
WRN7809T-500	24	11-28	9.0	3.0-11.5	500	95	87
WRN7812T-500	24	14-28	12	4.5-13.5	500	95	90
WRN7815T-500	24	17-28	15	4.5-15.5	500	96	92

Note:

1. Answer for Vin-Vo>2V if needed to adjust the output voltage;
2. If input voltage above specified may cause permanent damage to the device.
3. WRN7812T-500, WRN7815T-500 is not allowed to operate under no load.

SPECIFICATIONS

Characteristics	Conditions	Min.	Typ.	Max.	Units
Input voltage range	See selection guide	4.5	12/24	28	V
Output voltage adjust range	See selection guide	1.8		15.5	V
Output voltage accuracy	Input voltage range at full load		±2	±3	%
Line regulation	Input voltage range at full load		±0.2	±0.5	%
Load regulation	Nominal Input , 10% to 100% load		±0.3	±0.75	%
Ripple and Noise	20MHz bandwidth		10	25	mVp-p
Short circuit protection mode	Hiccup mode				
Short circuit protection	Continuous, automatic recovery				
Output current limit			1.8		A
Dynamic load stability	100%<->10% load		±30	±75	mV
Quiescent current	Normal input (3.3V, 5V output)		15		mA
Thermal shutdown	Internal IC junction		160		℃
Temperature coefficient	-40℃ to +85℃ ambient			±0.02	%/℃
Max capacitance load				1000	μF
ON/OFF control current	ON: open or 1.5<Vc<=6V OFF:GND or 0V<Vc<1V		2		μA
Shutdown input current			15	30	μA
ON/OFF shutdown threshold voltage		1.1	1.25	1.4	V
Operating temperature range		-40		±85	℃
Operating case temperature				±100	℃
Storage temperature range		-55		±125	℃
Lead temperature	1.5mm from case for 10 seconds			300	℃
Storage humidity range				95	%
Cooling		Free Air Convection			
Case material		Plastic (UL94-V0)			
MTBF	(MIL-HDBK-217F,+25℃)	2000			K hours
Package weight			2.3		g



TYPICAL TEMPERATURE CURVE

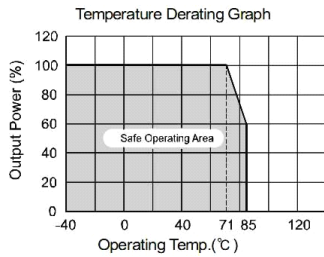

EXTERNAL CAPACITOR TABL

Part Number	C1 (Ceramic capacitor)	C2 (Ceramic capacitor)
WRN7803T-500	10uF/50V	22uF/16V
WRN7805T-500	10uF/50V	22uF/16V
WRN7809T-500	10uF/50V	22uF/16V
WRN7812T-500	10uF/50V	10uF/25V
WRN7815T-500	10uF/50V	10uF/25V

STANDARD APPLICATION CIRCUIT

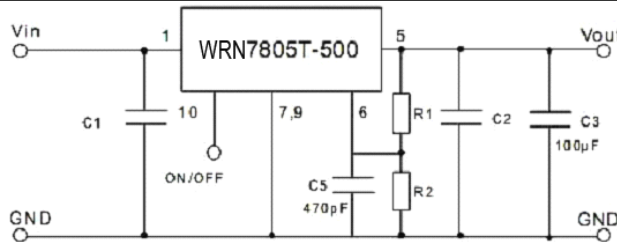

1. C1,C2: Choose a ceramic type capacitors; C3 is require , for best performance , use a 100uF or more capacitor please.
2. C1,C2 are require and should be placed close to the pins of the converter, with shortest possible traces.
3. No parallel connection or plug and play.

ADJUSTMENT RESISTOR VALUES

Model	WRN7803T-500		WRN7805T-500		WRN7809T-500		WRN7812T-500		WRN7815T-500	
Vo (nominal)	3.3V		5.0V		9V		12V		15V	
Adjusted range	1.8V-5.5V		2.5V-8V		3V-11.5V		4.5V-13.5V		4.5V-15.5V	
Regulated voltage	R1(kΩ)	R2(kΩ)	R1(kΩ)	R2(kΩ)	R1(kΩ)	R2(kΩ)	R1(kΩ)	R2(kΩ)	R1(kΩ)	R2(kΩ)
1.8V	24.31									
2.5V	98.9		25.28							
3.0V	364		47.6		3.1					
3.3V			67.3		5.79					
3.6V		129.1	95.8		8.47					
3.9V		59.1	140.9		11.8					
4.5V		24.3	411		19.14		4.55		2.69	
4.9V		15.25	2060		25.77		8.05		5.55	
5.0V		14.05			27.3		9.16		6.17	
5.1V		12.8		208.5	29.22		10.41		6.98	
5.5V		8.65		58.5	37.8		15		10	
6.5V				15.57	70.8		29.8		18.5	
7.2V				7.8	115.3		43.5		26.2	
8.0V				3.15	243.1		64.8		36.7	
9.0V							105		52.9	
10.0V							18.84	180.6	76.3	
11.0V							4.47	370	111	
11.5V							1.61	635	134.1	
12.0V									167.7	
13.0V								40.6	277.8	
13.5V								15	385	
14.0V									586	
14.5V									1128	
15.0V										
15.5V										88.2

Note: The above dates only are as reference, you could make corresponding adjustment with actual output when they are at practical application.

TEST CONFIGURATIONS (TA=25°C)

1 Efficiency and Output Voltage Ripple Test

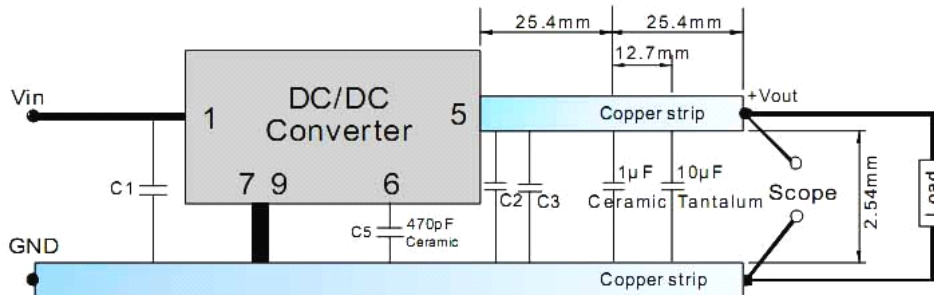

2 Start-up and Load Transient Response Test

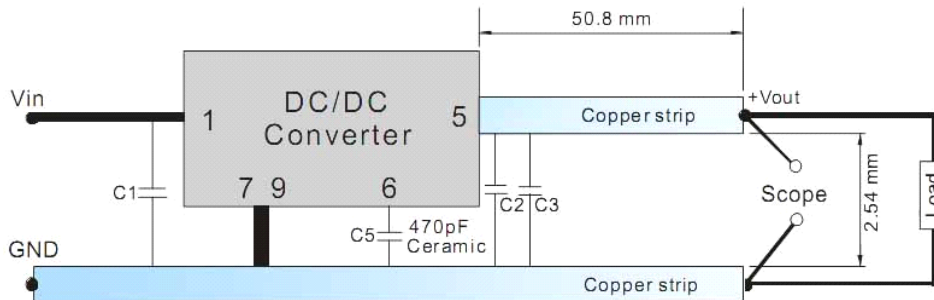

APPLICATION EXAMPLE

1. To reduce output ripple, it is recommended to add a LC filter to output port.

L: Recommended parameter $10\mu\text{H} \sim 47\mu\text{H}$.

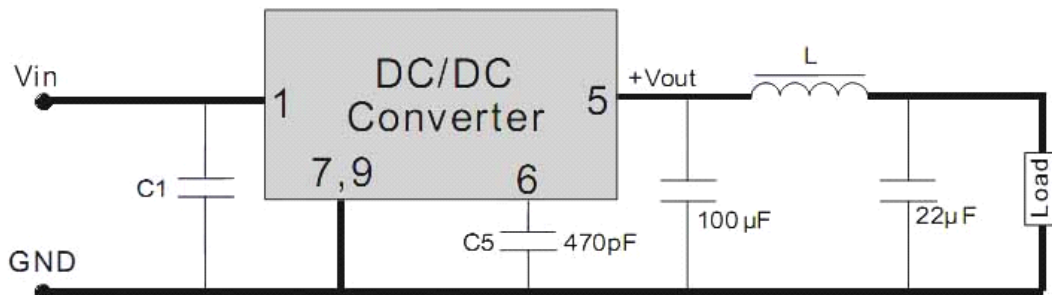

SHUTDOWN CONTROL

The ON/OFF pin provides several features for adjusting and sequencing the power supply, a user has the flexibility of using the ON/OFF pin as:

- 1) A digital on/off control by pulling down the ON/OFF pin with an open-drain transistor.

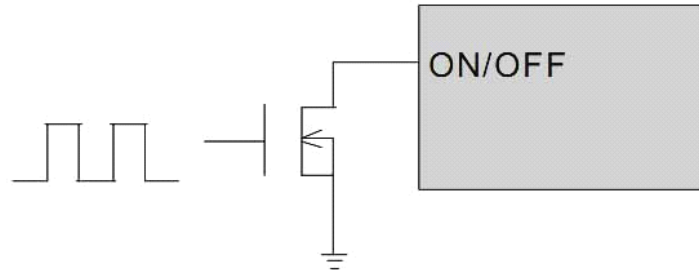

- 2) Line UVLO. If desired to achieve a UVLO voltage, an resistor divider from V_{in} to ON/OFF to GND can be used to disable the converter until a higher input voltage is achieved. For example, it is not useful for a converter with 12V output to start up with a 12V input voltage, as the output cannot reach regulation. To enable the converter when the input voltage reaches 14V, a 51k Ω /5k Ω resistor divider from V_{in} to GND can be connected to the ON / OFF pin. Both the precision 1.25V threshold and 150mV hysteresis are multiplied by the resistor ratio, providing a proportional 12% hysteresis for any startup threshold. So, the turn off threshold would be between 12.3V to 15.7V.

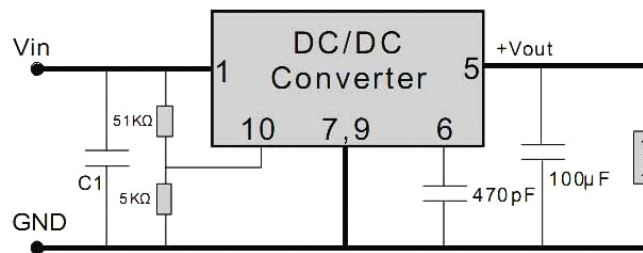

- 3) Power supply sequencing. By connecting a small capacitor from ON/OFF to GND, the 2 μ A current source and 1.25V threshold can provide a stable and predictable delay between startup of multiple power supplies. For example, a startup delay of roughly 64mS is provided using 100nF, and roughly 136mS by using 200nF.

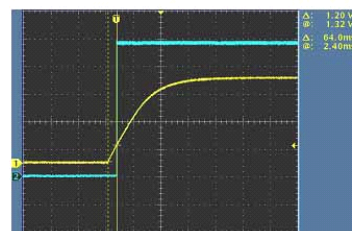
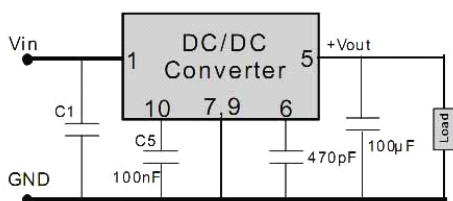

CH1: V_{in}/off
CH2: V_o
Delay time: 64mS

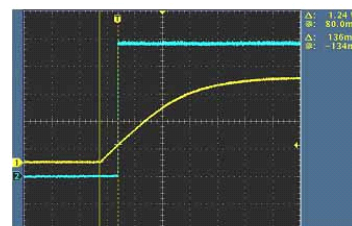
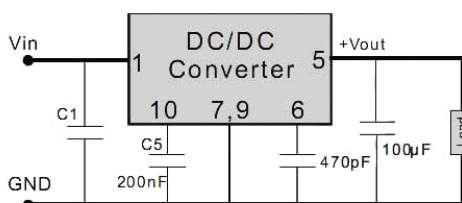

CH1: V_{in}/off
CH2: V_o
Delay time: 136mS

CHARACTERISTIC CURVE (TA=25°C)

Efficiency and Output Voltage Ripple

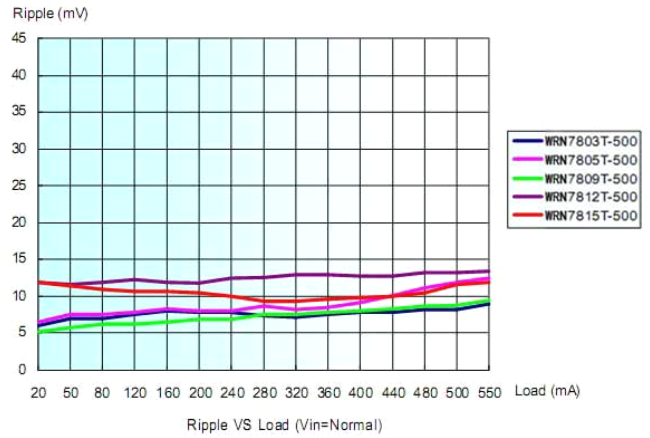
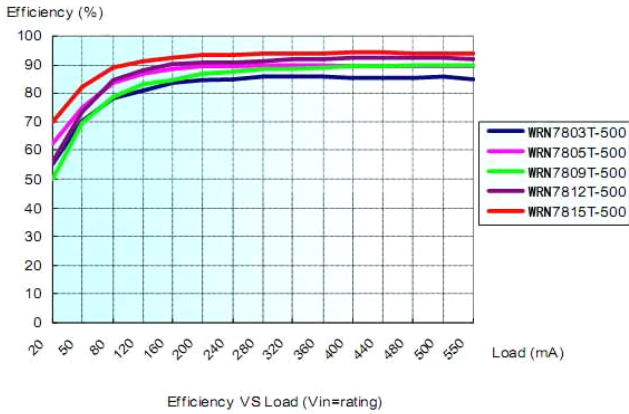

Efficiency VS Output Load (Vin=Norm)

Output Voltage Ripple VS Output Load (Vin=Norm)

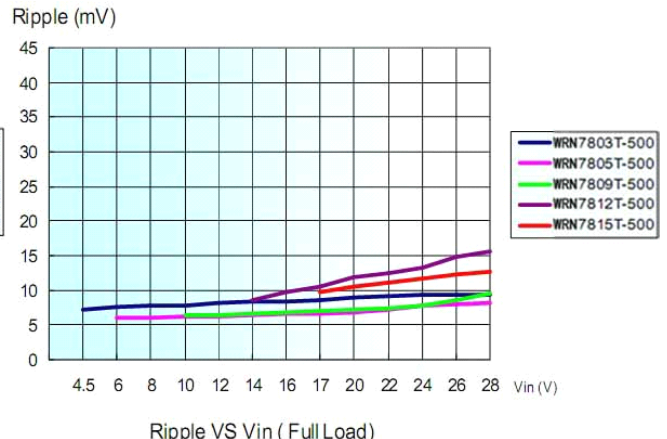
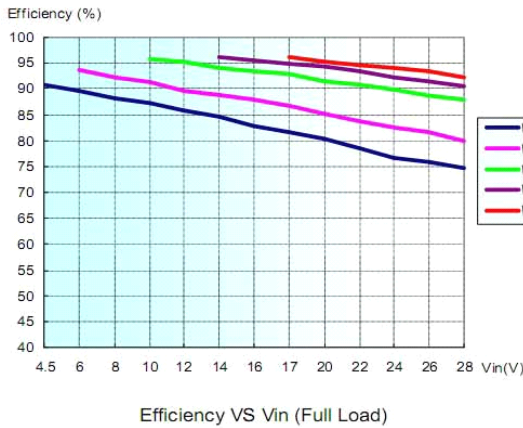

Efficiency VS Input Voltage (Full Load)

Output Voltage Ripple VS Input Voltage (Full Load)

TAPING REEL DIMENSIONS

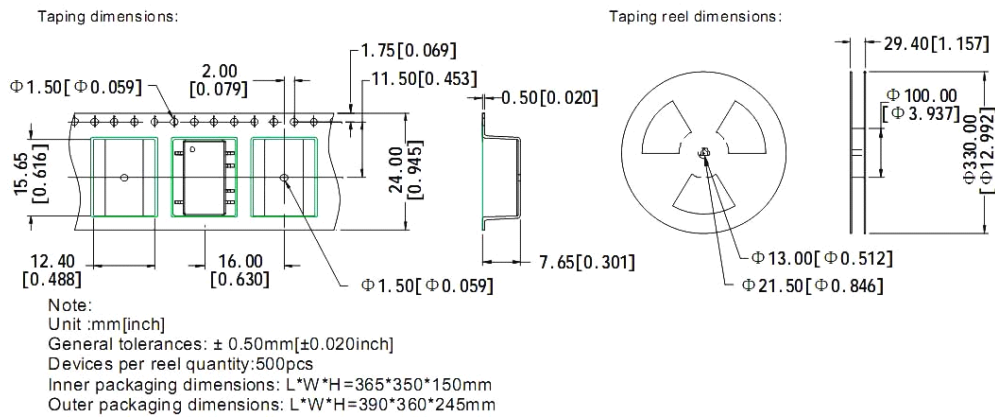

Note:
 Unit :mm[inch]
 General tolerances: $\pm 0.50\text{mm}[\pm 0.020\text{inch}]$
 Devices per reel quantity:500pcs
 Inner packaging dimensions: L*W*H=365*350*150mm
 Outer packaging dimensions: L*W*H=390*360*245mm

PACKAGE STYLE AND PINNING

MECHANICAL DIMENSIONS

WRN78XXT-500 Series

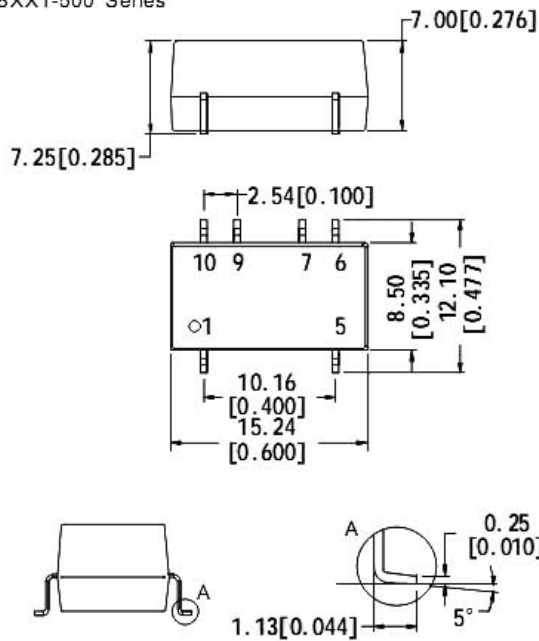

Note:
Unit: mm[inch]
Pin tolerances: $\pm 0.10\text{mm} [\pm 0.004\text{inch}]$
General tolerances: $\pm 0.25\text{mm} [\pm 0.010\text{inch}]$

FOOTPRINT DETAILS	
Pin	Function
1	Vin
7,9	GND
5	Vout
6	Vadj
10	ON/OFF

RECOMMENDED FOOTPRINT

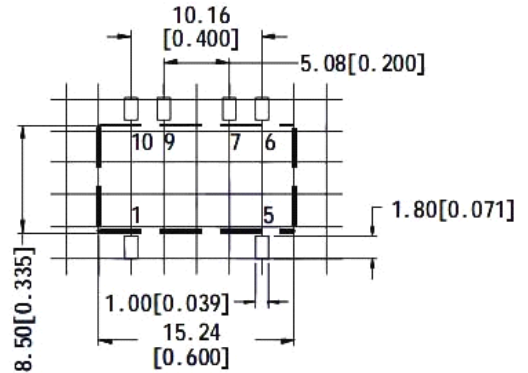

Note:
grid: 2.54*2.54 mm.

TUBE OUTLINE DIMENSIONS

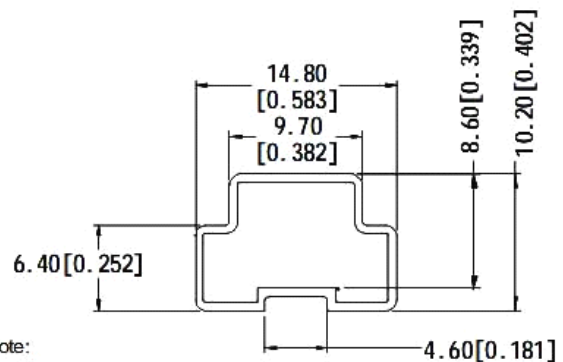

Note:
Unit :mm[inch]
General tolerances: $\pm 0.50\text{mm} [\pm 0.02\text{inch}]$
L=530mm[20.866inch] Tube Quantity: 33pcs
L=220mm[8.661inch] Tube Quantity: 13pcs
Short tube inner packaging dimensions: L*W*H=255*170*80mm
Short tube outer packaging dimensions(with six inner packaging boxes):
L*W*H=375*280*270mm
Long tube inner packaging dimensions: L*W*H=580*200*100mm
Long tube outer packaging dimensions(with two inner packaging boxes):
L*W*H=600*215*220mm
Long tube outer packaging dimensions(with three inner packaging boxes):
L*W*H=600*215*325mm

RoHS COMPLIANT INFORMATION

This series is compatible with RoHS soldering systems with a peak wave solder temperature of 300° C for 10 seconds.
The pin termination finish on the SIP package type is Tin Plate, Hot Dipped over Matte Tin with Nickel Preplate. The DIP types are Matte Tin over Nickel Preplate. Both types in this series are backward compatible with Sn/Pb soldering systems.

REACH COMPLIANT INFORMATION

This series has proven that this product does not contain harmful chemicals, it also has harmful chemical substances through the registration, inspection and approval.